

ROBUST HIGH QUALITY FLOW MONITORS

V2 and V25 with Two Setpoint Contacts
Small and compact version



Mechanical Flow Monitor for Liquids & Gases



The V-series is a very robust and reliable flow monitor for harsh and dusty industrial environment. The V2 and V25 are a result of a high demand for a smaller version of the Eletta V-series and two switches instead of just one.

The compact design, appr. 60 % smaller than V1 and V15 series, permits installation in places with very limited space is available and still keeps the proven reliability which characterize all Eletta Flow Products.

The V2 and V25 series has two microswitch setpoints. They are independently adjustable within the measuring range and can be set for high or low flow alarms for example to protect expensive equipment in various piping systems.

The Monitor is insensitive to surrounding magnetic fields and it combines the long standing proven mechanical function with outstanding reliability.

- Monitoring flows in cooling and lubricating circuits
- Two setpoints, independently adjustable
- Antifreeze protection of heat pump systems
- Dry out protection
- Starting and stopping pump motors
- Low cost solution for difficult flow applications
- Interchangeable control units to fit all pipe sections
- Not affected by static pressure
- Mechanical microswitches - works without external power
- Replaceable orifice in all models (GL, FA, GSS, FSS) to change the flow measuring range or media.
- Flow Direction changeable in all models, by turning the internal selector in GL & FA and by adding a block in GSS & FSS to change from default "L" to "R".

The V-series Flow Monitor

The Eletta Flow Monitor's function is based on the proven and dependable differential pressure principle. This is perhaps the oldest and most widely used principle for flow metering, mainly because of its simplicity and its relatively low cost.

The Eletta V-series Flow Monitor is used to control flow of liquids and gases in pipes from 15 mm to 500 mm. Through the two adjustable SPDT micro switches it is possible to set low or high flow alarm to protect expensive equipment in various piping systems. The switching points are highly repeatable, within <2%.

The Flow Monitor is insensitive to surrounding magnetic fields and it combines the long-standing proven mechanical function with outstanding reliability. Together with an exceptionally sturdy and robust design, this makes it extremely well suited for difficult environments.

The V-series comes in two measuring ratios which means that the V2 has a measuring span of 1:2 and the V25 has a span of 1:5. Like all Eletta Flow Monitors the V-series can monitor both liquids and gases.

Modular design

All the Eletta Flow Monitors including the V-, D- and S-series can be fitted to any of the various Eletta Flow Monitor Pipe Sections to suit your application.

The Instrument consists of two parts mainly, i.e. the Pipe Section and the Control Unit. The Pipe Section is the part that is to be mounted in the process pipe and the Control Unit is mounted directly (standard) or remote onto the Pipe Section.

As the Control Unit is pre-calibrated before leaving our production facilities, you can change pipe sections in the field to fit other dimensions and materials than originally ordered without recalibration.

A manifold with shut-off valves can be ordered as an extra addition which is mounted between the control unit and pipe section. This enables removal of the indicating unit without having to empty the system.

Eletta's Special Effects



Separate Version

Eletta can also provide several specials, like separate pipe section and Control unit, for example to avoid vibrations.

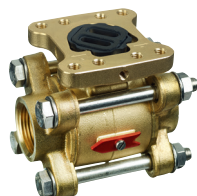

Flow Direction change

Easy to change, just unlock 4 screws and turn the flow direction selector to the right direction of your installation. Available on -GL and -FA series.

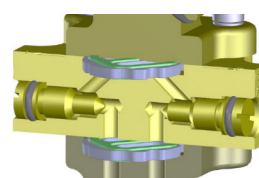

Shut-off valves

As an option we have a manifold with shut-off valves. This enables you to dismount the Control Unit from the Pipe Section during full operation.



Web Configurator

Visit our website and configure your own Eletta Flow Monitor.
www.eletta.com



V2 and V25-series with two switches and in a small and compact format



V2/V25-GL

The V-series Flow Monitor with PA 12 Grilamid housing and threaded brass pipe connection. Available in BSP/NPT threads from 15-40 mm (1/2" - 1 1/2").



V2/V25-FA

The V-series Flow Monitor with PA 12 Grilamid housing and flanged pipe connection in painted steel. Available in DIN/ANSI from 15-400 mm (1/2" - 16").



V2/V25-GSS

The V series Flow Monitor with PA 12 Grilamid housing and threaded stainless steel pipe connection. Available in BSP/NPT threads from 15-25 mm (1/2-1").

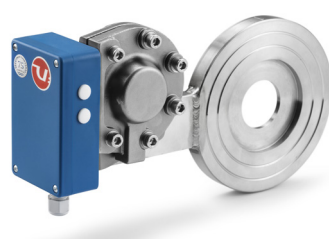

V2/V25-FSS

The V-series Flow Monitor with PA 12 Grilamid housing and flanged pipe connection in stainless steel. Available in DIN/ANSI from 15-500 mm (1/2-20").

The V2/V25 series

As a result of a high demand for a smaller version of the Eletta Flow V-series we have designed the V2 and V25 series.

The V2 and V25 have two independent SPDT switches for alarms and they can be set individually over the full flow range.

Flow range	0,4–25 000 l min (liquid), to choose the right range, see table of ranges page 4
Flow turndown	V2 - 1:2 V25 - 1:5
Wetted Material	Copper alloy, painted steel. stainless steel, 316 L
Rubber Parts	Nitrile (HNBR), EPDM and Fluorinated rubber (FPM)
Min. pressure	Appr. 700 – 1000 mbar (0,7–1 bar)
Max. pressure	16 bar (232 PSI)
Max. temp. Control Unit	90°C
Max. temp. Pipe Section	-GL and -FA: 120°C (248°F) -GSS, -FSS: 250°C (482°F)
Enclosure	IP43
Process Connection	DN 15–40, BSP/NPT thread DN 15–500 DIN/ANSI flange (wafer)
Alarm Contacts	2 micro switches SPDT contact, adjustable within the ordered Flow range.
Micro switch spec	Contact surfaces are silver plated as standard. Type: SPDT Hysteresis: 10% Rating AC Voltage: 4 A @ 250 VAC Rating DC Voltage: 5 A resistive, 2,5 A inductive @ 28 Vdc
Repeatability	<2% actual

For complete specification of various models please refer to the manual.

Certificates



Measuring Ranges

Eletta Flow Monitors



V2 (50-200 mbar)			
Dim. DN		lit/min	
1/2" DN 15	GL, GSS FA, FSS	0,4 - 0,8	
		0,6 - 1,2	
		1 - 2	
		1,6 - 3,2	
		2 - 4	
		2,4 - 4,8	
		3,2 - 6,4	
		4 - 8	
		6 - 12	
		8 - 16	
		10 - 20	
12 - 24			
16 - 32			
3/4" DN 20	GL, GSS FA, FSS	4 - 8	
		6 - 12	
		8 - 16	
		10 - 20	
		12 - 24	
		16 - 32	
20 - 40			
1" DN 25	GL, GSS FA, FSS	8 - 16	
		10 - 20	
		12 - 24	
		16 - 32	
		24 - 48	
		36 - 72	
		40 - 80	

		FA, FSS	50 - 100
		1 1/4" DN 32	FA, FSS
28 - 56			
40 - 80			
60 - 120			
80 - 160			
1 1/2" DN 40	GL FA, FSS	20 - 40	
		28 - 56	
		40 - 80	
		60 - 120	
		80 - 160	

FA, FSS	100 - 200		
2" DN 50	FA, FSS	40 - 80	
		60 - 120	
		80 - 160	
		120 - 240	
		160 - 320	
2 1/2" DN 65	FA, FSS	60 - 120	
		80 - 160	
		120 - 240	
		160 - 320	
		240 - 480	
280 - 560			
3" DN 80	FA, FSS	120 - 240	
		160 - 320	
		240 - 480	
		320 - 640	
		400 - 800	
4" DN 100	FA, FSS	160 - 320	
		280 - 560	
		400 - 800	
		600 - 1200	
		700 - 1400	
5" DN 125	FA, FSS	400 - 800	
		600 - 1200	
		800 - 1600	
		1000 - 2000	
6" DN 150	FA, FSS	600 - 1200	
		800 - 1600	
		1200 - 2400	
		1400 - 2800	
		1500 - 3000	
8" DN 200	FA, FSS	800 - 1600	
		1200 - 2400	
		1600 - 3200	
		2400 - 4800	
		2500 - 5000	
10" DN 250	FA, FSS	1600 - 3200	
		2000 - 4000	
		3200 - 6400	
		4000 - 8000	

V25 (22-550 mbar)				
Dim. DN		lit/min		
1/2" DN 15	GL, GSS FA, FSS	0,4 - 2		
		1 - 5		
		2 - 10		
		4 - 20		
		6 - 30		
		8 - 40		
		3/4" DN 20	GL, GSS FA, FSS	4 - 20
				6 - 30
8 - 40				
15 - 75				
1" DN25	GL, GSS FA, FSS	6 - 30		
		12 - 60		
		16 - 80		
		24 - 120		

FA, FSS	30 - 150			
1 1/4" DN 32	FA, FSS	8 - 40		
		20 - 100		
		40 - 200		
		50 - 250		
1 1/2" DN 40	GL, FA, FSS	8 - 40		
		20 - 100		
		40 - 200		
		60 - 300		
2" DN 50	FA, FSS	20 - 100		
		40 - 200		
		70 - 350		
		100 - 500		
2 1/2" DN 65	FA, FSS	20 - 100		
		50 - 250		
		100 - 500		
		160 - 800		
3" DN 80	FA, FSS	40 - 200		
		80 - 400		
		160 - 800		
		240 - 1200		
4" DN 100	FA, FSS	80 - 400		
		160 - 800		
		250 - 1250		
		400 - 2000		
5" DN 125	FA, FSS	100 - 500		
		200 - 1000		
		400 - 2000		
		600 - 3000		
6" DN 150	FA, FSS	200 - 1000		
		400 - 2000		
		600 - 3000		
		900 - 4500		
8" DN 200	FA, FSS	400 - 2000		
		600 - 3000		
		1000 - 5000		
		1500 - 7500		
10" DN 250	FA, FSS	600 - 3000		
		1000 - 5000		
		1600 - 8000		
		2400 - 12000		

It is possible to order a lower range than indicated.
Other ranges can be quoted upon request.



Weight and Dimensions



V - GL						
Type	D	A mm	B mm	C mm	E mm	Weight kg*
-GL15	1/2"	66	140	30	80	2,6
-GL20	3/4"	66	140	30	80	2,6
-GL25	1"	66	140	30	80	2,6
-GL40	1 1/2"	76	150	40	80	3,6
V - FA						
Type	d mm	D mm	A mm	B mm	Weight kg*	
-FA15	16 (1/2")	53	143	70	3,6	
-FA20	22 (3/4")	63	147	70	4,1	
-FA25	30 (1")	73	154	70	4,1	
-FA32	39 (1 1/4")	84	160	70	4,6	
-FA40	43 (1 1/2")	94	165	70	5,6	
-FA50	55 (2")	109	173	70	5,6	
-FA65	70 (2 1/2")	129	183	70	6,6	
-FA80	82 (3")	144	190	70	7,6	
-FA100	107 (4")	164	200	70	7,6	
-FA125	132 (5")	194	215	70	9,6	
-FA150	159 (6")	219	228	70	10,6	
-FA200	207 (8")	274	256	70	14,6	
-FA250	260 (10")	330	283	70	18,6	
-FA300	310 (12")	385	313	70	20,6	
-FA350	340 (14")	445	338	70	34,6	
-FA400	390 (16")	498	368	70	40,1	
V - GSS						
Type	D	A mm	B mm	C mm	Weight kg*	
-GSS15	G 1/2"	89	127	34	2,6	
-GSS20	G 3/4"	89	127	34	2,6	
-GSS25	G 1"	89	127	34	2,6	
V - FSS						
Type	d mm	D mm	A mm	B mm	Weight kg*	
-FSS15	16 (1/2")	53	158	15	2,6	
-FSS20	22 (3/4")	63	165	15	2,6	
-FSS25	30 (1")	73	171	15	2,6	
-FSS32	39 (1 1/4")	84	178	15	2,6	
-FSS40	43 (1 1/2")	94	184	15	2,6	
-FSS50	55 (2")	109	191	15	2,6	
-FSS65	70 (2 1/2")	129	202	15	3,1	
-FSS80	82 (3")	144	210	15	3,1	
-FSS100	107 (4")	164	220	15	3,6	
-FSS125	132 (5")	194	235	15	4,1	
-FSS150	159 (6")	219	257	15	4,6	
-FSS200	207 (8")	274	285	15	6,1	
-FSS250	260 (10")	330	313	15	7,6	
-FSS300	310 (12")	385	341	15	9,1	
-FSS350	340 (14")	445	371	18	14,1	
-FSS400	390 (16")	498	418	18	16,1	

*Approximate weight

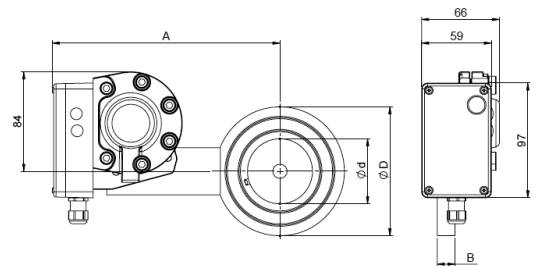
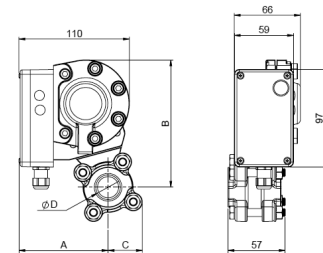
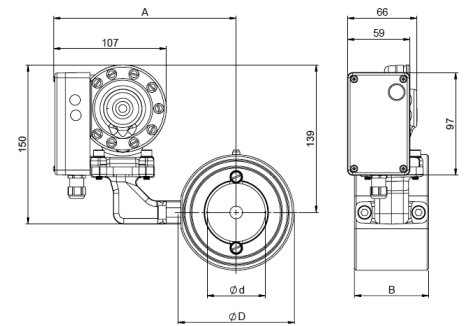
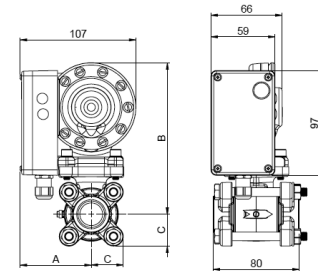

Ordering code

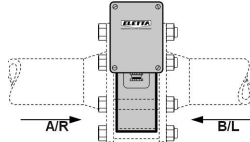
Serie			
V			
Measuring span			
2	1:2	50-100% of max measuring range e.g. 10-20 l/min	
25	1:5	20-100% of max measuring range e.g. 10-50 l/min	
Indicating unit			
-		Standard, PA 12 Grilamid	
Pipe section			
GL		Thread, brass	
FA		Flange painted steel	
GSS		Thread stainless steel	
FSS		Flange stainless steel	
Dimension			
15	1/2"	Thread GL, GSS or Flange FA, FSS	
20	3/4"	Thread GL, GSS or Flange FA, FSS	
25	1"	Thread GL, GSS or Flange FA, FSS	
32	1" 1/4	Flange FA, FSS	
40	1" 1/2	Thread GL or Flanged FA, FSS	
50	2"	Flange FA, FSS	
65	2" 1/2	Flange FA, FSS	
80	3"	Flange FA, FSS	
100	4"	Flange FA, FSS	
125	5"	Flange FA, FSS	
150	6"	Flange FA, FSS	
200	8"	Flange FA, FSS	
250	10"	Flange FA, FSS Larger dimensions on request	
Media			
		Water	
		Oil	
		Gas Please specify: Pressure, working temperature and type of gas	
		Other Please specify: Media, pressure, density, viscosity, pressure and working temperature	
Installation alternative			
A/R		A/R - Left to right in a horizontal pipe B/L - Right to left in a horizontal pipe	
B/L			
Measuring range			
See separate table			
Options			
A	Chemical nickel plated (for GL only)	E	ANSI connection
B	Customized alarm set point	F	Rubber parts in other material
C	Mark on tag plate	G	Separate mounting kit
D	NPT connection	H	Manifold with shut-off valves

Example of Code

V2-GL15, Water, A/R, 4-8 l/min

All combinations are not possible so please check upon ordering.